

Water Penetration Resistance - Design and Detailing

Abstract: Proper design, detailing and construction of brick masonry walls are necessary to minimize water penetration into or through a wall system. Many aspects of design, construction and maintenance can influence a wall's resistance to water penetration. The selection of the proper type of wall is of utmost importance in the design process as is the need for complete and accurate detailing. In addition to discussing various wall types, this *Technical Note* deals with proper design of brick masonry walls and illustrates suggested details which have been found to be resistant to water penetration.

Key Words: barrier, design, detailing, drainage, flashing, installation, rain, wall types, weeps.

SUMMARY OF RECOMMENDATIONS:

Wall System Selection:

- Drainage walls provide maximum protection against water penetration
- Barrier walls are designed to provide a solid barrier to water penetration and provide good water penetration resistance
- Single wythe masonry walls require careful detailing and construction practices to provide adequate water penetration resistance

Through Wall Flashing Locations:

- Install at wall bases, window sills, heads of openings, shelf angles, tops of walls and roofs, parapets, above projections, such as bay windows, and at other discontinuities in the cavity

Through-Wall Flashing Installation:

- Lap continuous flashing pieces at least 6 in. (152 mm) and seal laps
- Turn up the ends of discontinuous flashing to form end dams
- Extend flashing beyond the exterior wall face
- Terminate UV sensitive flashings with a drip edge

Weeps:

- Open head joint weeps spaced at no more than 24 in. (610 mm) o.c. recommended
- Most building codes permit weeps no less than $\frac{3}{16}$ in. (4.8 mm) diameter and spaced no more than 33 in. (838 mm) o.c.
- Wick and tube weep spacing recommended at no more than 16 in. (406 mm) o.c.

INTRODUCTION

This *Technical Note* is the first in a series addressing water resistance of brick masonry. Design considerations and details are provided to illustrate the principles involved in addressing water penetration issues. The other *Technical Notes* in this series provide detailed guidance in the areas of material selection (7A) and construction (7B). *Technical Notes* 7C and 7D provide information on condensation.

When masonry walls encounter problems, water-related issues are often one of the primary factors. If a wall is saturated with water, freezing and thawing may cause cracking, crazing, spalling and disintegration over time. Water can cause masonry to experience dimensional changes, metals to corrode, insulation to lose its effectiveness, interior finishes to deteriorate and efflorescence to appear on exterior surfaces. Water penetration may also provide the moisture necessary for the development of mold growth on susceptible wall elements.

Water resistance of a masonry wall depends on four key factors: design, including detailing; materials; construction; and maintenance. Attention to all four is necessary to produce a satisfactorily performing wall. Failure to properly address any one factor can result in water penetration problems.

Water is abundant in many forms. Rain and snow contact building materials, wetting them. Water vapor is present in the air from many sources. As a result, since water cannot be completely eliminated, water penetration must be controlled. When water passes through brick masonry walls, it typically does so through minute separations between the brick units and the mortar joints. Under normal exposures, it is virtually impossible for significant amounts of water to pass directly through the brick units or through the mortar. Highly absorbent brick will absorb some water, but certainly do not contribute to an outright flow of water through a wall.

Before brick veneer became popular, masonry walls usually functioned as both the structural system and as the exterior skin of the building. As a result, these masonry walls were quite massive, ranging in thickness from 12 in.

(305 mm) up to 6 ft (1.83 m) of solid brick. These masonry walls, both because of their thickness and their being in constant compression due to the structural loads, worked quite well in keeping water out of the interior of the building. Many older masonry walls were built with cornices and other ornamentation which helped to protect the faces of the buildings from excessive water rundown and subsequent water penetration to the interior.

Walls used today are much less massive, and the masonry may be only 3 in. (76 mm) or less in thickness. In many cases, they have minimal overhang at the top, allowing sheeting of the rain water from the roof or parapet down to the ground. As a result of these newer wall systems, rain water is allowed to be in contact with the masonry in larger quantities and for longer periods of time, thus leading to more opportunity for water penetration problems.

The successful performance of a masonry wall depends on limiting the amount of water penetration and controlling any water that enters the wall system. If water penetration can be minimized, for all practical purposes, the wall system will perform well.

DESIGN

The first factor in evaluating water penetration resistance of masonry is that of design. Proper design of masonry does not mean just proper structural design. Design includes fire resistance, heat transmission, structural integrity, material compatibility, sound reduction, aesthetics and water resistance. Other *Technical Notes* provide guidance on each of these different design factors.

Design for water resistance requires evaluation of several items, including: (1) sources of moisture; (2) selection of wall type; and (3) flashing and weeps. Each of these items will be addressed separately.

Sources of Moisture

Moisture is present almost everywhere in various forms, i.e., rain, snow, condensation, ground water, construction water, etc. Some of these lend themselves to control; some do not. This section deals with wind-driven rain. Interstitial condensation and its control are discussed in *Technical Notes 7C* and *7D*.

Wind-Driven Rain. The exposure to which a masonry wall will be subjected is very important to the proper design of the wall. No single standard design can be expected to perform equally well under all exposures.

Exposures vary greatly throughout the United States, from severe on the Atlantic Seaboard and Gulf Coast, where rains of several hours' duration may be accompanied by high velocity winds; to moderate in the Midwest and Mississippi Valley, where wind velocities are usually lower; to slight in the arid areas of the West. Refer to [Figure 1](#).

Selection of Wall Type

The selection of the proper wall type to use in any given situation is very important. Under normal conditions, it is nearly impossible to keep a heavy wind-driven rain from penetrating a single wythe of brickwork, regardless of the quality of the materials or the degree of workmanship used.

The best approach to designing a water resistant wall is to design the wall assuming some water penetrates the surface. Therefore, the objective is

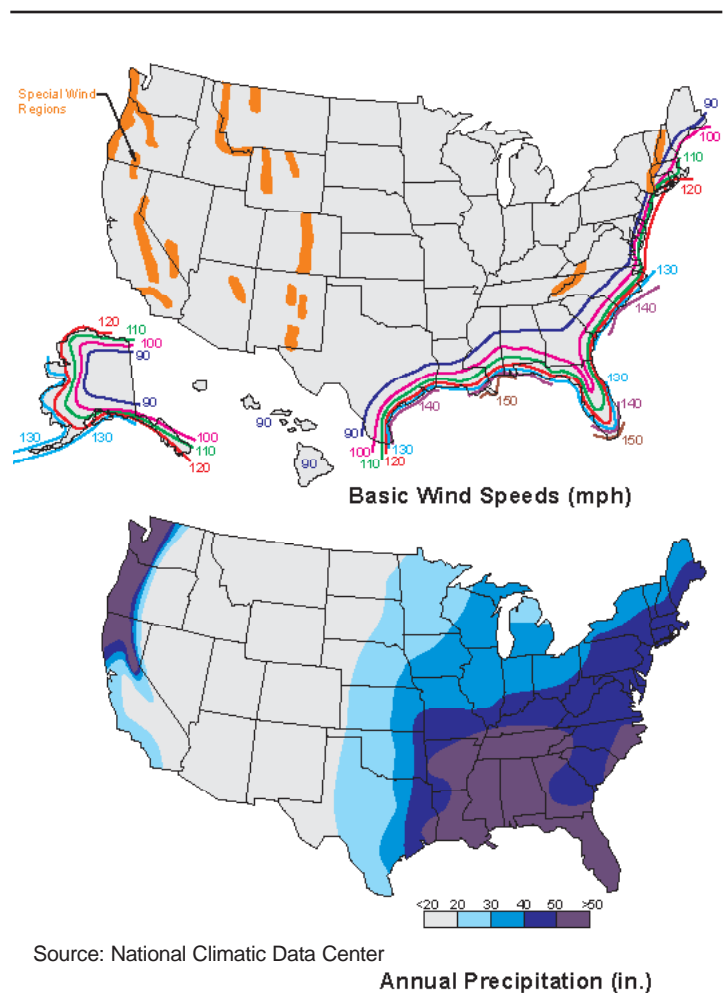

Figure 1
Wind Speed and Precipitation

to control the moisture once it begins to penetrate the wall. Two basic wall systems are used for this purpose: the drainage wall and the barrier wall.

Drainage Wall Systems. Drainage wall systems include cavity walls (metal-tied and masonry-bonded hollow walls in historical applications), and anchored veneer walls as shown in **Figures 2 through 5**. The basic concept behind the drainage wall assumes a heavy, wind-driven rain will penetrate the exterior wythe of brickwork. When it does, the wall is designed to allow the water to flow inward to the air space or cavity between the wythes. The water then flows down the back face of the outer brick wythe, where it is collected on the flashing and redirected out of the wall system through the weeps. Properly designed, detailed and constructed drainage wall systems are excellent with respect to water penetration resistance. Specific detailed information on all aspects of cavity wall systems can be found in the *Technical Notes 21 Series*. The *Technical Notes 28 Series* addresses anchored veneer wall systems.

Barrier Wall Systems. Barrier wall systems, such as the one shown in **Figure 6**, include multi-wythe walls with mortar- or grout-filled collar joints (including composite brick and concrete block walls), reinforced brick masonry walls and adhered veneer walls. The basic concept is that when a wind-driven rain penetrates the exterior wythe of

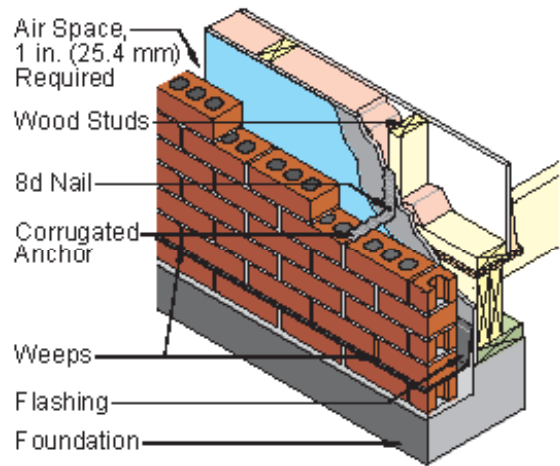

Figure 2
Brick Veneer/Wood Stud Wall

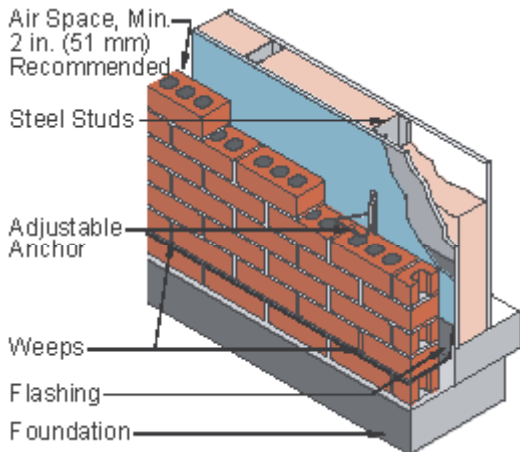

Figure 3
Brick Veneer/Steel Stud Wall

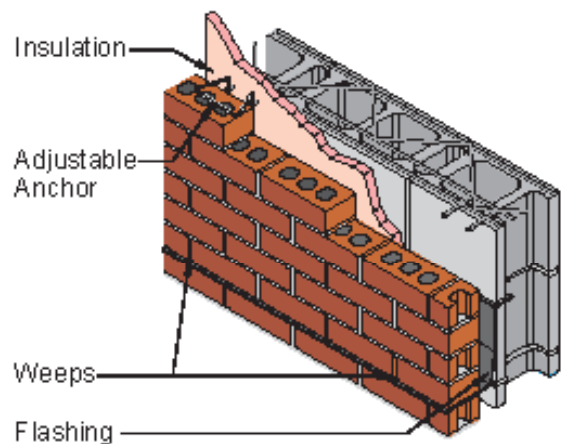

Figure 4
Insulated Brick/CMU Wall

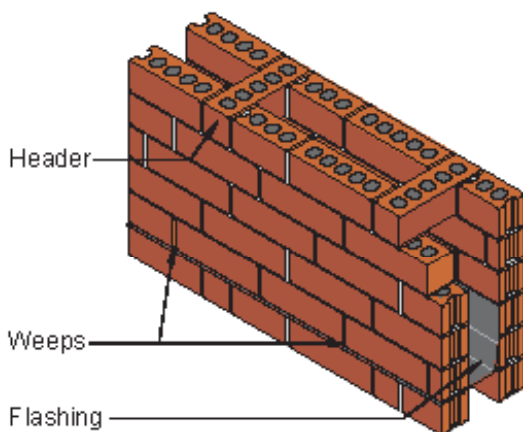

Figure 5
Masonry Bonded Hollow Wall

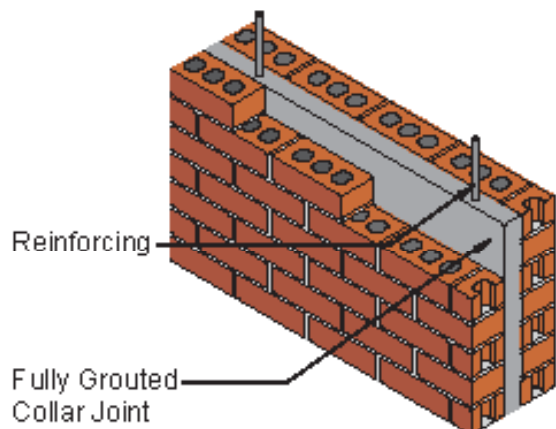

Figure 6
Reinforced Barrier Wall

masonry it migrates inward toward a filled collar joint that acts as a barrier to prevent further inward movement. The water then migrates back out of the wall system. The key item is that the collar joint must be completely filled with grout or mortar to provide a monolithic barrier to moisture. Grouting is the most effective method of ensuring that collar joints are completely filled. However, grouting spaces less than $\frac{3}{4}$ in. (19.1 mm) is not recommended. In these instances, the face of the inner masonry wythe should be parged and the back of brick in the exterior wythe buttered in order to fill the collar joint. Placing mortar in the collar joint with a trowel after the individual wythes are laid, commonly referred to as "slushing", does not result in completely filled joints, and is not recommended. Flashing is also integrated into barrier walls to aid in controlling water that penetrates the exterior wythe. Properly designed, detailed and constructed barrier wall systems work well with respect to water penetration resistance.

Single-Wythe Walls. Single-wythe masonry walls can be considered a variation of a barrier wall system. Single-wythe brick masonry construction can be designed with either solid or hollow units. In single-wythe walls, the masonry wythe usually exceeds the thickness of a nominal 4 in. (102 mm) exterior brick wythe. In addition to the added thickness, grouted cells help to prevent water from penetrating to the interior of the wall system. The single-wythe wall design is not inherently as resistant to water penetration as are drainage wall systems or multi-wythe barrier wall systems and may not be appropriate for some severe exposures. With careful detailing and good construction practices however, they can perform well. For example vertically reinforced and grouted brickwork often provides good water penetration resistance. With single-wythe masonry, it is especially important to use a mortar joint profile that sheds, rather than collects water. Concave and "V" joints are preferred over raked joints, for example. See *Technical Note 7B* for further information. Penetrating water repellents can increase the water resistance of single-wythe walls. See *Technical Note 6A* for further information.

DETAILING

Through-Wall Flashing

Through-wall flashing is a membrane, installed in a masonry wall system, that collects water that has penetrated the exterior wythe and facilitates its drainage back to the exterior. Such flashing is essential in a drainage wall system, and is required as a second line of defense in a barrier wall system. Proper design requires flashing at wall bases, window sills, heads of openings, shelf angles, projections, recesses, bay windows, chimneys, tops of walls and at roofs. Flashing should extend vertically up the backing a minimum of 8 in. (203 mm). The water-resistant barrier on the backing should lap the top of the flashing. Examples of water-resistant membranes include No. 15 asphalt felt, building paper, certain high-density polyethylene or polypropylene plastics (housewraps) and certain water-resistant sheathings. Various types of flashing materials which may be used in the design of brick masonry and composite walls are covered in *Technical Note 7A*.

In regard to flashing, the designer must also address the following considerations:

Extension Through Wall. When possible, flashing should extend beyond the face of the wall to form a drip as shown in [Figure 7](#). When using a flashing that deteriorates with UV exposure, a metal or stainless steel drip edge can accomplish this. It is imperative that flashing be extended at least to the face of the brickwork.

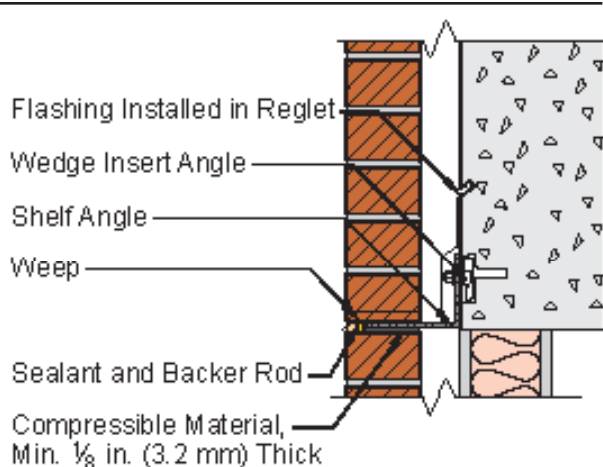

Figure 7
Shelf Angle Flashing

Continuity. Flashing is not usually installed in one long, continuous sheet. As a result, pieces must be fitted together on the job. Flashing pieces should be lapped at least 6 in. (152 mm) and the laps sealed with mastic or an adhesive compatible with the flashing material. Self-adhesive flashing should be considered as an alternate.

Flashing Around Corners. To achieve flashing continuity around corners, preformed corner pieces are available or the pieces of flashing may be cut, lapped and sealed to conform to the shape of the structure.

End Dams. Where the flashing is not continuous, such as over and under openings in the wall and on each side of vertical expansion joints, the ends of the flashing should be extended beyond the jamb lines on both

sides and turned up into the head joint at least 1 in. (25.4 mm) at each end to form a dam. Preformed end dams may also be used. Refer to **Figure 8**.

Flashing at Vertical Supports. In some cases, connections that support shelf angles make it necessary to cut, puncture or otherwise interrupt the flashing. When this occurs, it is important to make sure that all openings in the flashing are tightly sealed, and that the flashing is attached to these supports with mastic.

Weeps

In order to properly drain any water collected on the flashing, weeps are required immediately above the flashing at all locations. An open head joint, formed by leaving mortar out of a joint, is the recommended type of weep. Open head joint weeps should be at least 2 in. (51 mm) high. Weep openings are permitted by most building codes to have a minimum diameter of $\frac{3}{16}$ in. (4.8 mm). The practice of placing weeps in one or more courses of brick above the flashing can cause a backup of water and is not recommended. Non-corrosive metal, mesh or plastic screens can be installed in open head joint weeps if desired. Refer to **Figure 9**.

Spacing of open head joint weeps is recommended at no more than 24 in. (610 mm) on center. Spacing of wick and tube weeps is recommended at no more than 16 in. (406 mm) on center. Weep spacing is permitted by most building codes at up to 33 in. (838 mm) on center. Wicks should be at least 16 in. (406 mm) long and extend through the brick, into the air space and along the back of the brick.

Drainage

The air space must be kept clear of mortar and mortar droppings to allow proper drainage. Drainage materials may be specified that prevent mortar from entering the air space or catch mortar droppings at the wall base. These materials are usually made of a plastic mesh or fabric porous enough to allow passage of water, but catch or deter mortar from collecting at the base of the air space. The effects of mortar collection devices should be considered carefully as they may require modifications to typical details such as extending flashing more than 8 in. (203 mm) vertically up the backing. While it is not mandatory to include drainage materials, they may help to keep the air space open for drainage. However, the use of drainage materials should not preclude good workmanship and an effort to keep the air space clean.

Critical Locations

Wall Base. Moisture that enters a wall gradually travels downward. Continuous flashing must be placed above grade at the base of walls to divert this water to the exterior. In addition, base flashing prevents water from rising up into the wall system due to capillary action and helps prevent efflorescence. The elevation of flashing and weeps should be above planting beds, ground covering, sidewalks, etc. that are placed immediately adjacent to the wall. Once the designer has determined the level for placing flashing in the wall in accordance with the grad-

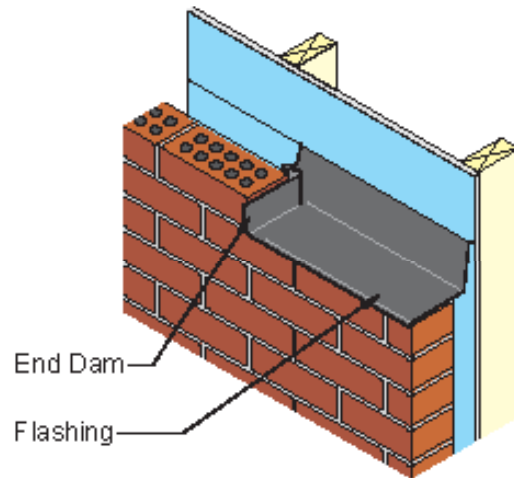

Figure 8
End Dam Detail

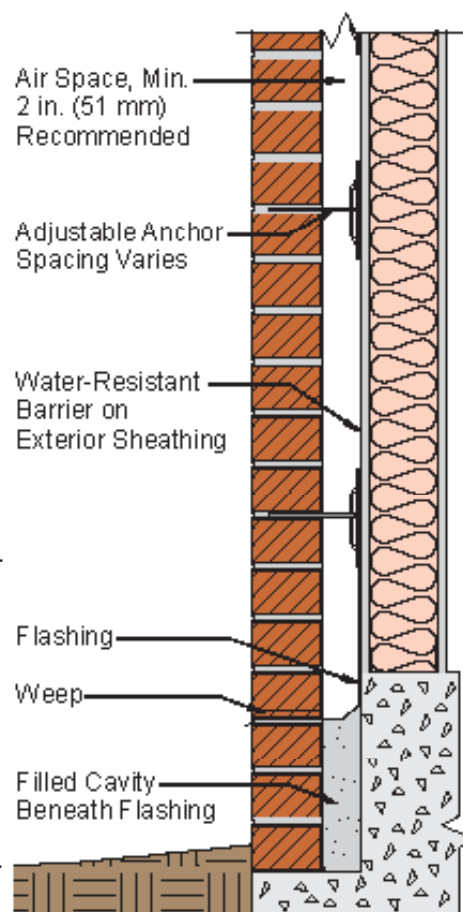

Figure 9
Flashing and Weeps

ing plans, care should be taken that field modifications do not result in any section of flashing being below grade. Refer to [Figure 10](#).

The top of the foundation stem wall should be above the elevation of the base flashing to prevent water from being directed toward the building interior. The cavity below base wall flashing should be solidly filled with mortar or grout.

Window Sills. Window sills should be sloped to drain; 15 degrees is recommended. Through-wall flashing must be placed under all sills as shown in [Figures 11 through 13](#) and turned up at the ends to form dams. Soffits and deep reveals may require special flashing considerations. The *Technical Notes 36 Series* contains further details and information.

Steel Lintels. Through-wall flashing should be installed over all openings including door and window heads as shown in [Figure 14](#). An exception may be those completely protected by overhangs. The flashing should be placed on a thin bed of mortar directly on top of the lintels and turned up at the ends to form dams. [Figure 15](#) shows several examples of lintels. Weeps are recommended above all lintels which require flashing.

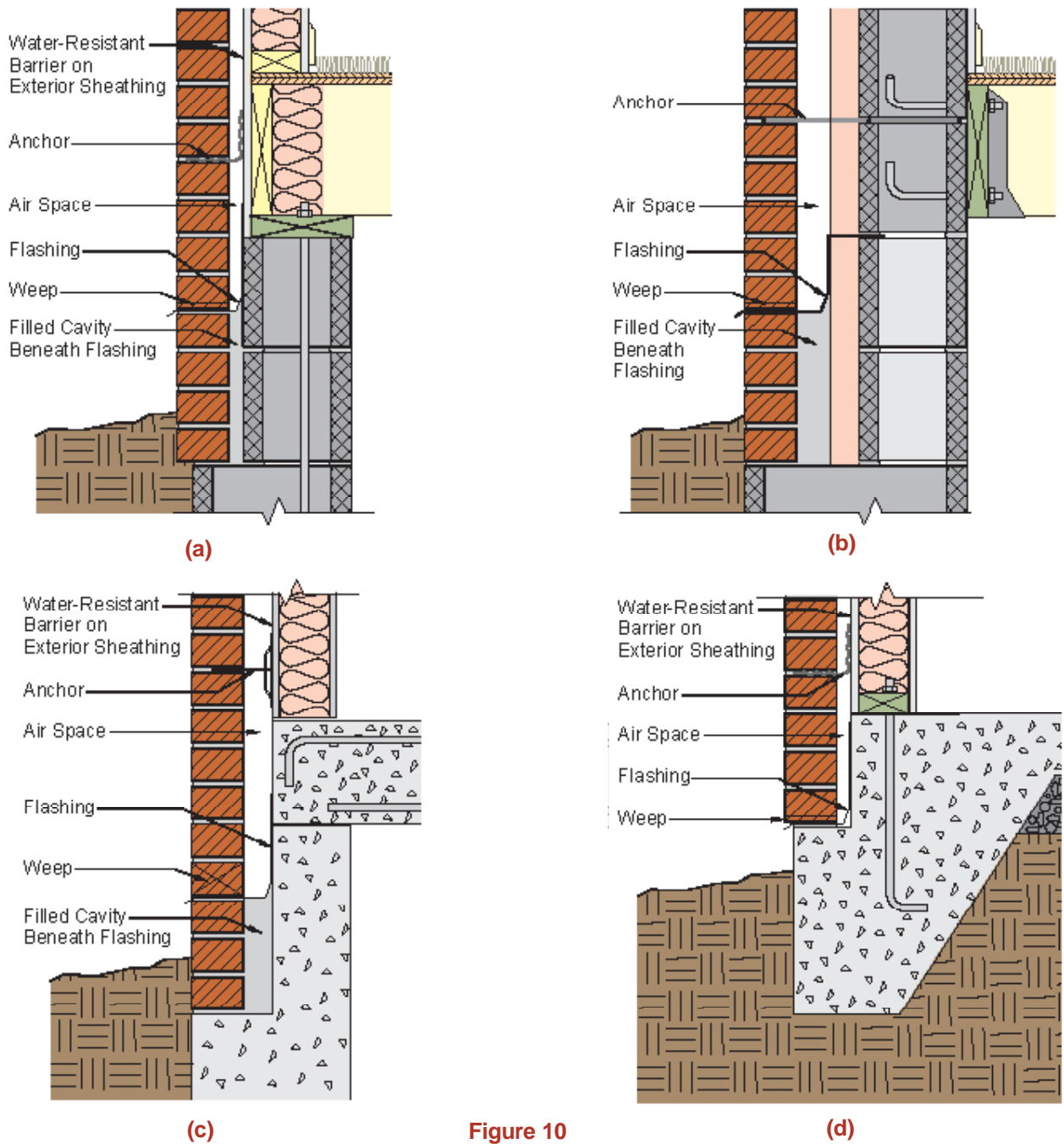

Figure 10
Wall Base Flashing

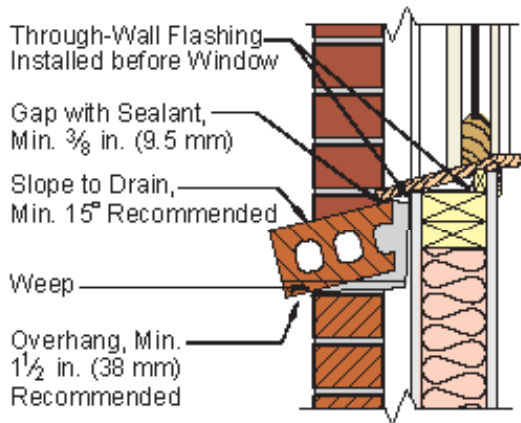

Figure 11

Window Sill in Brick Veneer/Frame Wall

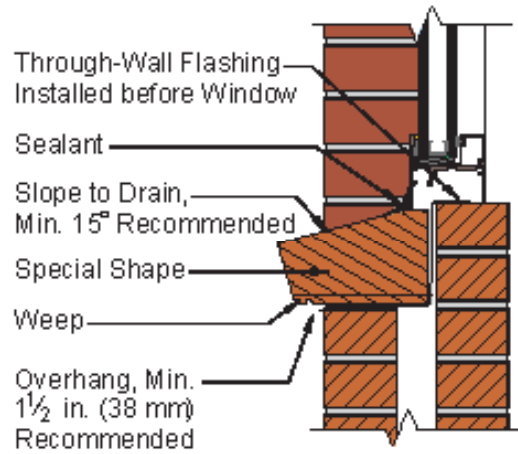

Figure 12

Window Sill in Cavity Wall

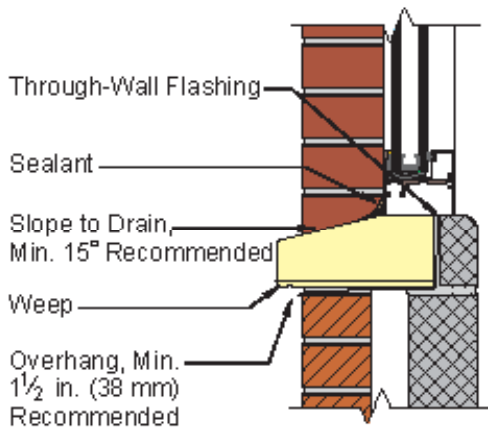
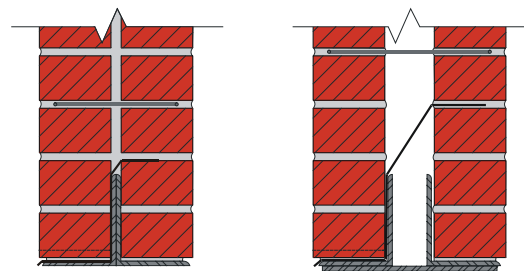

Figure 13

Precast Concrete or Stone Sill



Double Angle
Solid Wall

Double Angle
Hollow Wall

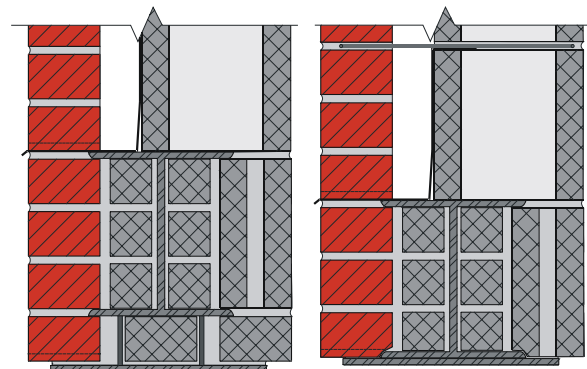

Steel Shape
Suspended Plate

Steel Shape
Attached Plate

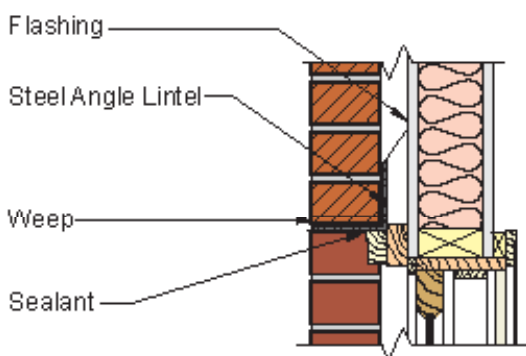

Figure 14

Window Head in Brick Veneer/Frame Wall

Figure 15

Structural Steel Lintels

Shelf Angles. In concrete or steel frame buildings with the brick wythe supported on shelf angles, the entire face of spandrel beam may be flashed or the flashing may be inserted in a continuous reglet installed in the spandrel beam or integrated with moisture-proofing on the spandrel beam. Refer to [Figure 8](#).

Projections, Recesses and Caps. Projections, recesses and caps tend to collect rain water and snow. They should be sloped away from the wall to drain and be flashed where possible as shown in [Figure 16](#). Other details and information can be found in the *Technical Notes 36 Series*.

Tops of Walls and Parapets. The tops of all walls and parapets should have an adequate cap or coping, and there should be flashing beneath the coping. Drainage-type parapet walls as shown in [Figures 17 and 18](#) are rec-

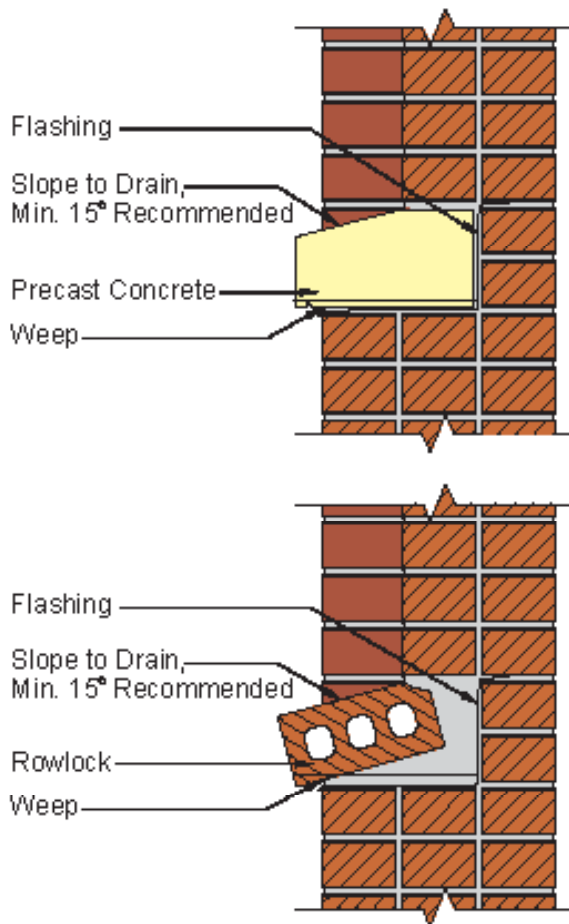

Figure 16
Projections and Caps

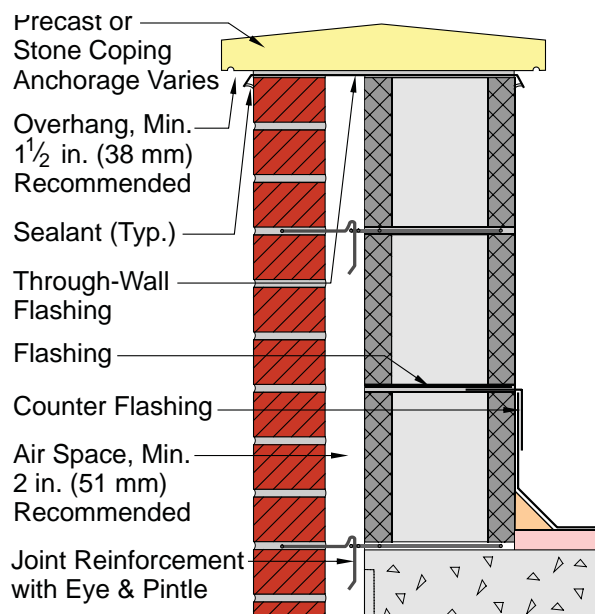

Figure 18
Metal Coping on Cavity Wall Parapet

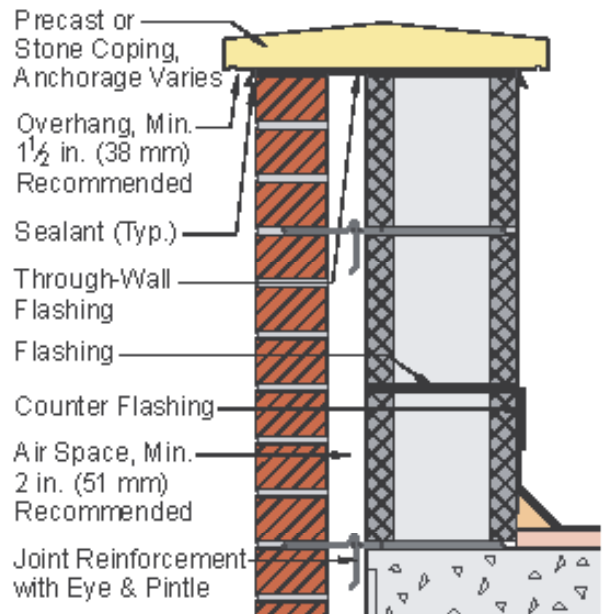

Figure 17
Precast Concrete or Stone Coping on Cavity Wall

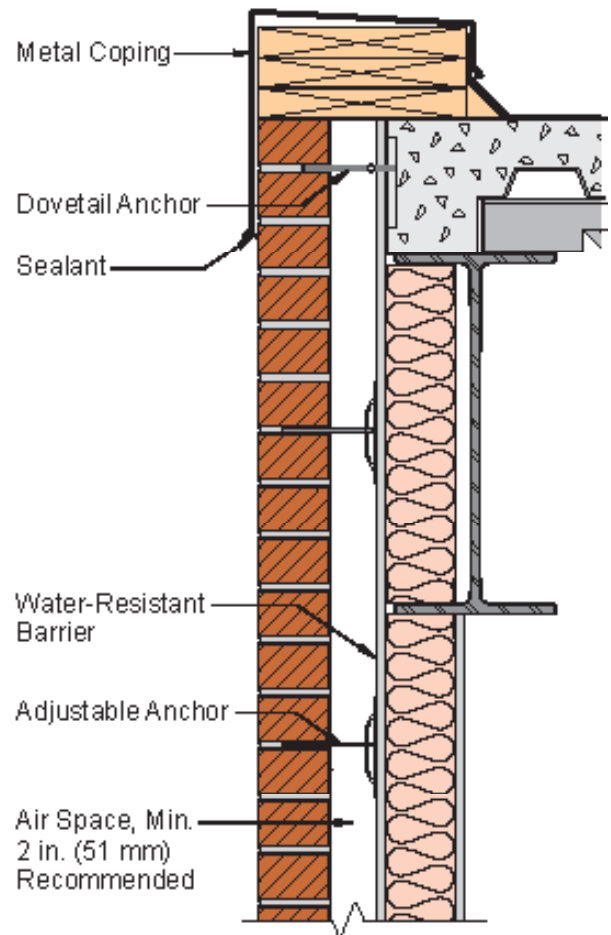

Figure 19
Non-Parapet Wall

ommended as the best parapet system for resistance to water penetration. The *Technical Notes 36 Series* provide more details and information on these subjects.

Metal copings, as shown in [Figure 19](#), are preferable to brick, cast stone, concrete or stone copings. Metal copings should extend down the face of the wall at least 8 in. (203 mm) with the bottom edge sealed against the masonry to prevent wind-blown rain from entering the wall. Copings of cast stone, concrete or stone must have joints between each element closed with sealants.

Roof Flashing. Because roof flashing is placed at very vulnerable points, it must be designed and installed with great care. Roof flashing design may depend upon the type of roofing used. Where the roof flashing is metal, the counter-flashing should also be metal, extending into the wall and overlapping the roof flashing a minimum of 3 in. (76 mm). Refer to [Figures 17 and 18](#).

SUMMARY

Masonry walls constructed of brickwork have performed well for centuries and are a testament to the performance and durability of brick. Design and detailing that maximizes the water penetration resistance of brickwork is needed to achieve this level of service.

Selection of the wall type should be based on the project's location, environmental conditions and building use. Water penetration resistance of brickwork is enhanced by including appropriate details that reduce water penetration at key points in the brickwork.

The information and suggestions contained in this Technical Note are based on the available data and the combined experience of engineering staff and members of the Brick Industry Association. The information contained herein must be used in conjunction with good technical judgment and a basic understanding of the properties of brick masonry. Final decisions on the use of the information contained in this Technical Note are not within the purview of the Brick Industry Association and must rest with the project architect, engineer and owner.

REFERENCES

1. ASTM E 2266, "Standard Guide for Design and Construction of Low-Rise Frame Building Wall Systems to Resist Water Intrusion", *Annual Book of Standards*, Vol. 04.12, ASTM International, West Conshohocken, PA, 2005.